

Stéphane Gagnon

Curriculum Vitae – English

2020-2021

stephane.gagnon@uqo.ca

Education

1988
1991

**B.Soc.Sc.
Economics &
International Politics**

University of Ottawa
Ottawa, Ontario, Canada

1991
1993

**M.A.
Public Administration**

Carleton University
Ottawa, Ontario, Canada

1995
2001

**Ph.D.
Business Administration**

Université du Québec à Montréal
Montréal, Québec, Canada

Technology Management

Strategic Management

Building New Innovation Capabilities:
A Synthesis of the Resource-Based and
Operations Strategy Perspectives, with
Applications to the Cases of Electric Vehicles
and Electronic Commerce

**Thesis of 3
published
articles**

Experience

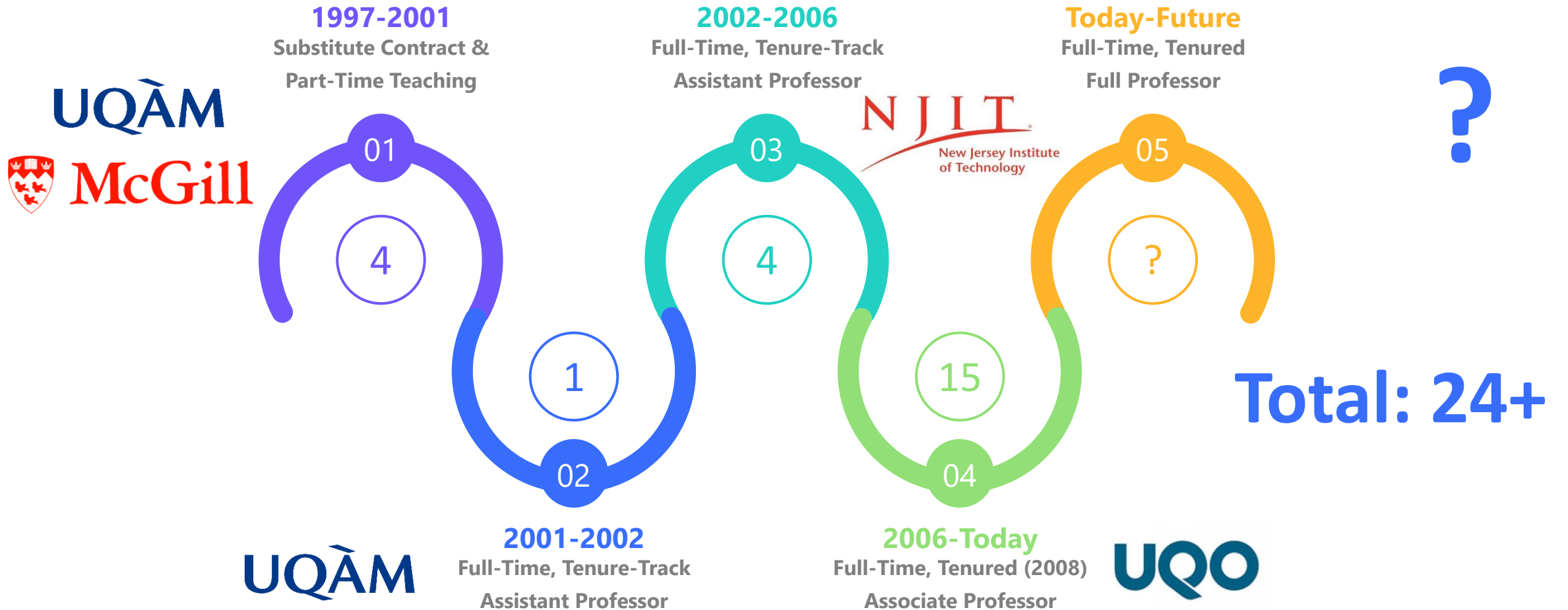

International

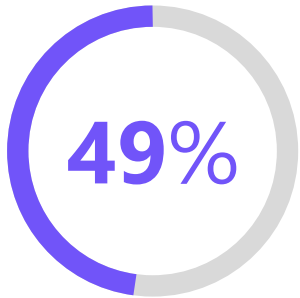

Teach Outside Canada

Total of 2890 students with
126 courses in 10 countries
in English, French & Spanish
(Studying Mandarin)

67%

Master & Doctoral Students

Project Management &
Information Technology



Courses

31

Information Systems
2001-2014

28

E-Commerce & E-Business
1999-2006

25

Project Management
1998-2020

15

Artificial Intelligence
2009-2017

14

Innovation Management
1998-2001

13

Strategic Management
1998-2016

Publications

Articles & Chapters

- Innovation Mgmt. (2020)
- SCM and AI Tech. (2020)
- BTM Competencies (2019)
- Wiki & Project KM (2017)
- IT in Healthcare (2016)
- Financial Risk Models (2016)
- News Trading (2013)
- Cloud Strategies (2011)
- BPM and SOA (2006)
- Innovation Strategy (1999)

18

Editorship & Reports

- Workshop Proceedings as co-chair (2005-2007)
- Reports to international institutions (2001-2003)

11

Conferences & Workshops

- BTM Standards (2020)
- Digital Transformation (2015)
- Cybersecurity (2015)
- SCM in Healthcare (2015)
- Rules-Based Text Mining (2011-2015)
- Semantic Web and Geomatics (2014)
- BPM, SOA, MDA (2004-2008)
- Innovation Strategy (2001-2003)

20

Speaker & Interviews

- Information Technology Strategy

35+

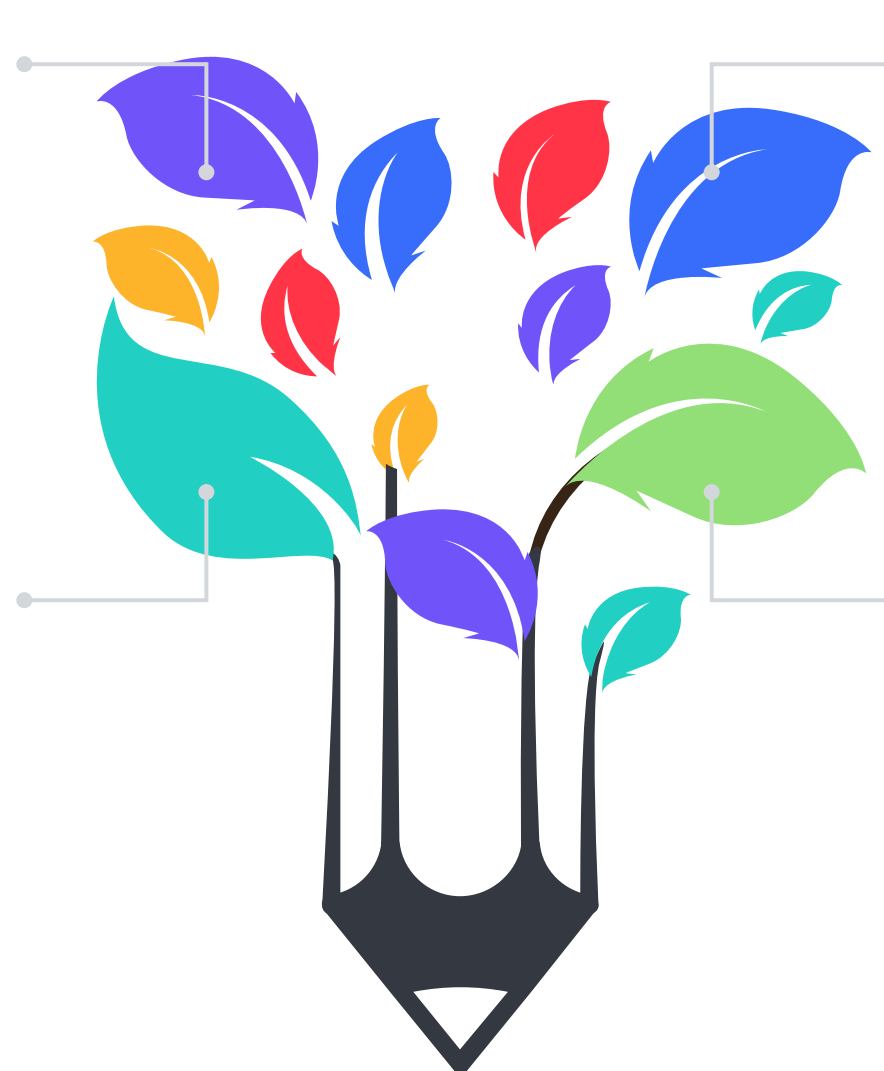

Research

AI Project
Management
Capabilities

Government Analytics
Research Institute (GARI)

<https://governmentanalytics.institute>

Digital Leadership
Competency Profiles

Business Technology
Management (BTM) Forum and
BTM Body of Knowledge (BOK)

<http://btmforum.org/standards/bok>

Project Management
Methodology (PM²)
Alliance

<https://www.pm2alliance.eu>

BTM Journal

<http://btmforum.org/btmjournal>

Research Projects and Doctoral Supervision

Management

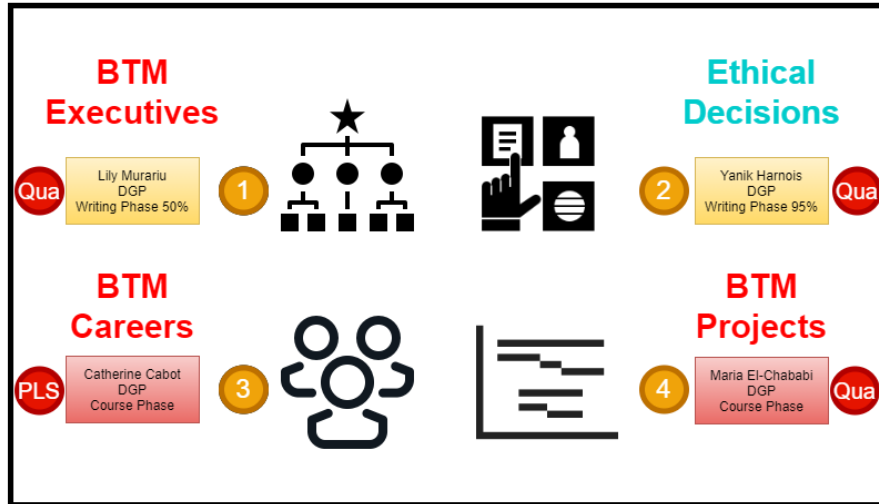

Implementation

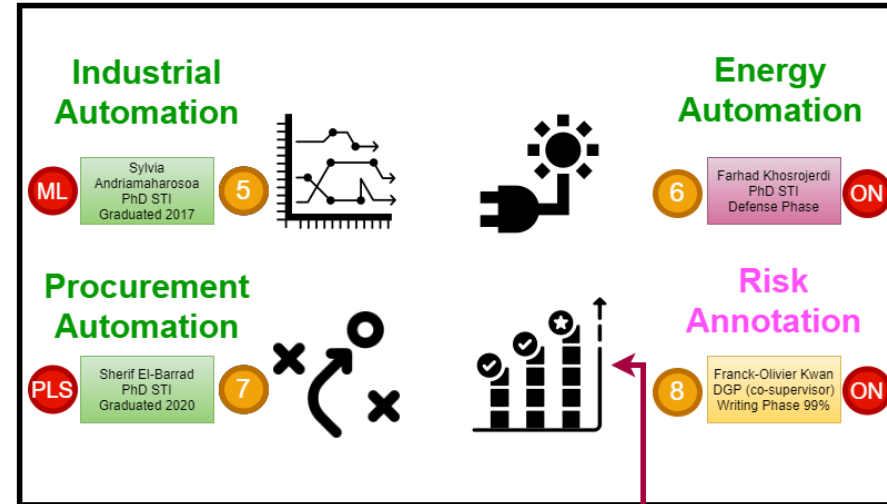

Methodologies

- Qualitative (3)
- PLS (2)
- Ontologies (6)
- Development / Design Science (4)
- ML - Machine Learning (1)

By Sept. 2021:
8 graduated of 16 supervised

Doctoral Programs

- Project Management (6 in DGP)
 - 3 at 95-99%
 - 1 at 50%
 - 2 in courses
- Info. Sc. and Tech. (10 in PhD STI)
 - 3 graduated
 - 1 defending
 - 1 at 95%
 - 1 at 50%
 - 3 proposing
 - 1 in courses

Research Areas

- Project Management and Digital Strategy
- Artificial Intelligence (AI) Implementation in Business Processes
- Knowledge-Based Systems and Ontology Reasoning
- Systems Design for Agent and Rules-Based Platform

Reasoning

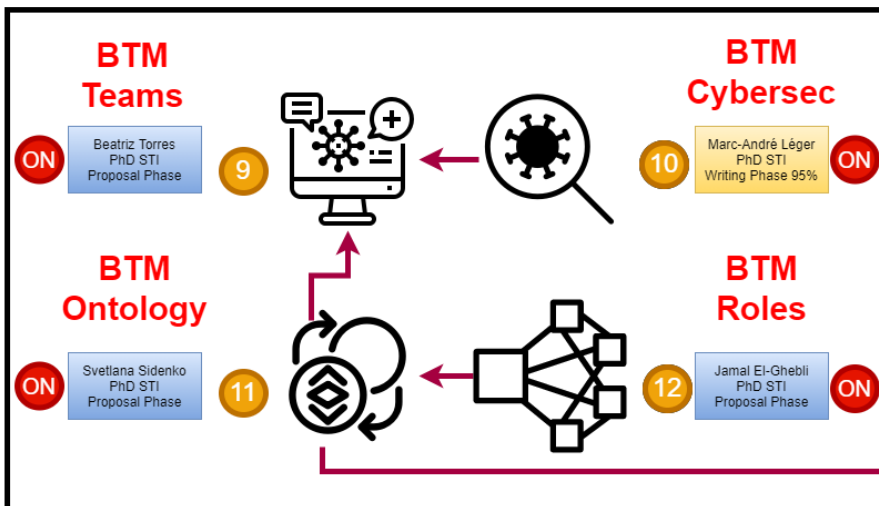

Platform

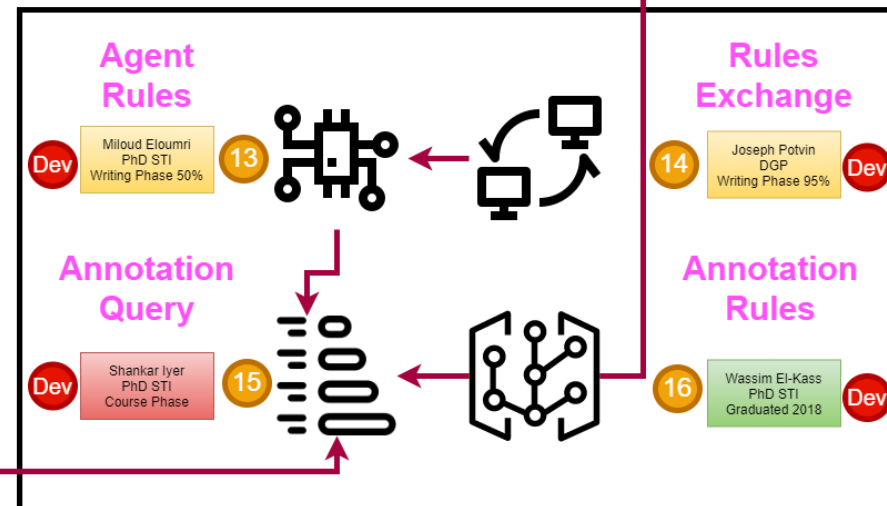

Research Projects

- Business Technology Management (BTM), Digital Transformation and IT Leadership
- Process Automation based on Artificial Intelligence (AI)
- Agent-Driven and Rules-Based Systems
- Ethical Decisions and Anti-Corruption Policy

Grants

IT Strategy	SOA and Startups	Healthcare IT	Language Tech.	Capability Models
2001-2006	2006-2011	2011-2013	2011-2016	2016-2021
<ul style="list-style-type: none"> Financial Market Monitoring Software Industry R&D SOA and BPM Infrastructure 	<ul style="list-style-type: none"> SOA and ERP Integration Cloud Startups Success Venture Capital Funds 	<ul style="list-style-type: none"> IT for Healthcare SCM Healthcare IT Automation Empower Patient with IT 	<ul style="list-style-type: none"> Semantic Mining of Text Knowledge Management Wiki and Team Performance 	<ul style="list-style-type: none"> Core BTM BOK Meta-Model BOK Integration and Reuse Analytics Capability Maturity
UQAM & NJIT	MDEIE, UQO & STO	iCare & UQO	UQO & MITACS	U of O/Carl., ITAC & MITACS, Ciena
US\$ 20,000 US\$ 20,000 CAN\$ 43,000	CAN\$ 12,472 CAN\$ 10,800 CAN\$ 8,706	CAN\$ 23,145 CAN\$ 10,000 CAN\$ 9,787	CAN\$ 7,943 CAN\$ 5,000 CAN\$ 2,000	CAN\$ 160,000 CAN\$ 10,000 CAN\$ 15,000 + 25,000 + 30,000
<ul style="list-style-type: none"> 5+ Equipment 2 Student Scholarships 2 Conferences 	<ul style="list-style-type: none"> 5+ Equipment 2 Student Scholarships 2 Conferences 	<ul style="list-style-type: none"> 5+ Equipment 2 Student Scholarships 2 Analytics Servers 	<ul style="list-style-type: none"> 10+ Equipment 2 Student Scholarships 2 Conferences 	<ul style="list-style-type: none"> 10+ Equipment 5 Student Scholarships 2 Conferences
Integrated Architecture	Cloud Success Factors	Patient-Centric Systems	Rules-Based Mining	Professional Standards

Main Project

Business Technology Management (BTM) Body of Knowledge (BOK)

2017-2021
IT Association of Canada & MITACS = CAN\$ 160,000

8 Doctoral Students
12 Student Scholarships
5 Faculty Reviewers

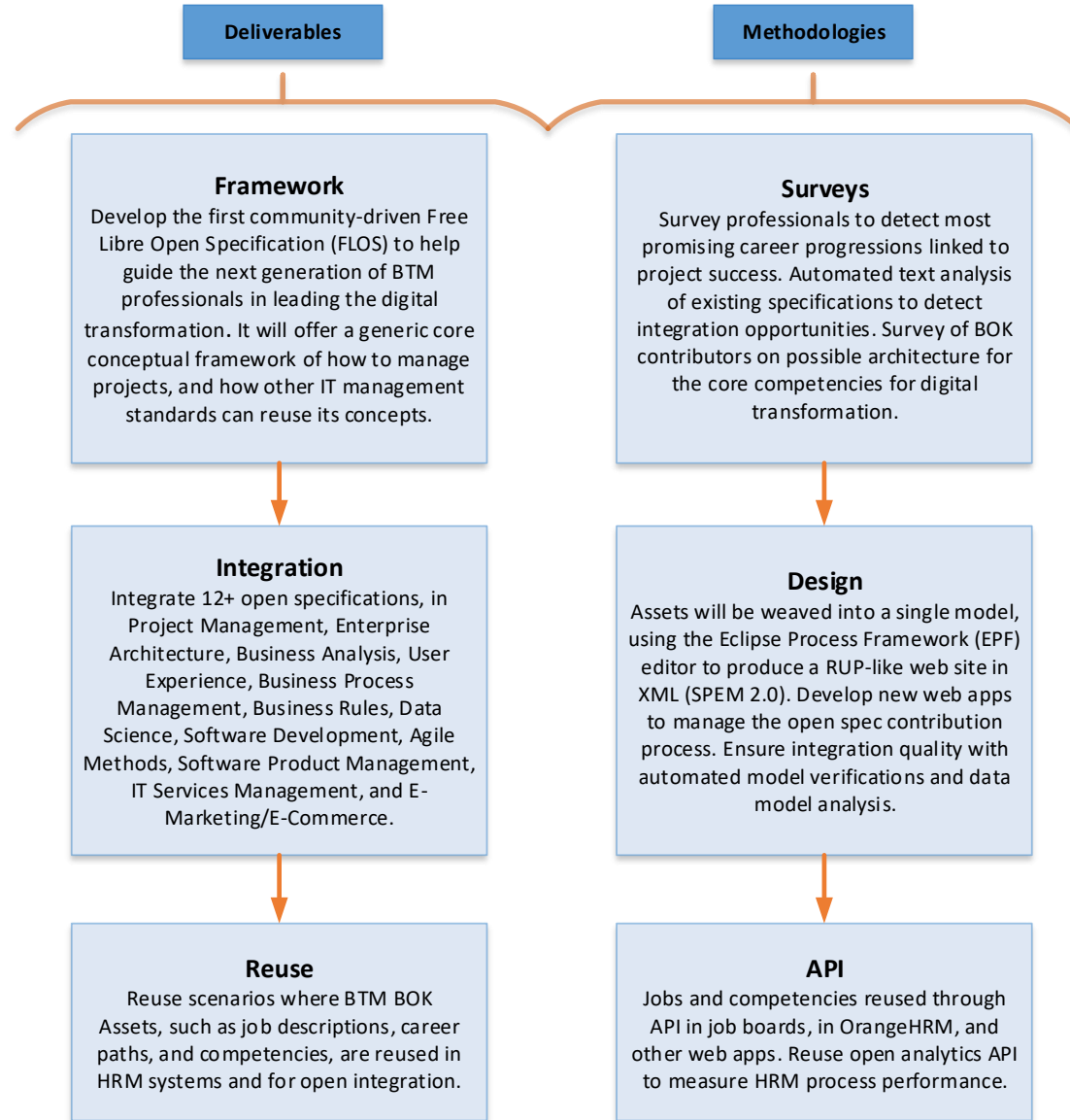

Objectives of BTM and BOK

1. **Business Technology Management (BTM)** as a new **profession** uniting Information Systems (IS) and IT Management (ITM) graduates.
2. Define seamless **career paths** across multiple specializations to ensure more complete experience and knowledge for **digital transformation**.
3. Develop **core meta-model** of a Body of Knowledge (BOK), building upon existing practices, to guide upcoming digital leaders toward the common core competencies of their profession.
4. Use BOK for **certification** of **digital leaders** at Associate, Professional, Manager, and Executive levels.
5. Use BOK for **accreditation** of degree programs, identify **most innovative schools**, focus on job requirements for **digital leadership**.

Thank You.

Looking Forward to Working Together.

Stéphane Gagnon, PhD.
Associate Professor
Business Technology Management (BTM)

Université du Québec en Outaouais

101, rue St-Jean-Bosco, A2228
Gatineau, Québec, Canada, J7X 3X7

stephane.gagnon@uqo.ca

+1.819.595.3900 x.1942

+1.819.639.6993



<https://uqo.ca/profil/gagnst02>



<http://www.gagnontech.org>